



LUXEON CoB with CrispWhite Technology (Gen 2)

Fashion retail lighting that makes an impact, revealing the whitest whites

The second generation of LUXEON CoB with CrispWhite Technology creates the most impactful retail lighting ever available by revealing the whitest whites. LUXEON CoB with CrispWhite Technology delivers a natural crisp whiteness by activating Fluorescent Whitening Agents (FWAs) in paints and fabrics to attractively display merchandise in retail shops; ideal for CDM/CMH replacement.



FEATURES AND BENEFITS

- Lumen packages from 500 to 5,000 lumens for a range of options
- Industry's smallest Light Emitting Surface (LES) for highest flux densities
- Up to 4x lower thermal resistance than competitors enabling smaller heatsinks and higher lumens
- Contains violet LEDs and does NOT contain UV LEDs for minimal amount of damage, much lower than any traditional CDM shop lighting
- Mouse bites for M2 and M3 make it easy to work with

PRIMARY APPLICATIONS

- Downlights
- High Bay & Low Bay
- Lamps
- Spotlights

Table of Contents

General Product Information	2
Product Test Conditions	2
Part Number Nomenclature	2
Lumen Maintenance	2
Environmental Compliance	2
Performance Characteristics	3
Product Selection Guide	3
Optical Characteristics	3
Electrical and Thermal Characteristics	4
Absolute Maximum Ratings	4
Characteristic Curves	5
Spectral Power Distribution Characteristics	5
Light Output Characteristics	5
Forward Current Characteristics	8
Radiation Pattern Characteristics	10
Color Bin Definitions	11
Mechanical Dimensions	12
Packaging and Labeling Information	14
Tube Dimensions	14
Inner Box	16
Outer Box	17

General Product Information

Product Test Conditions

LUXEON CoB with CrispWhite Technology (Gen 2) LEDs are tested and binned with a DC drive current specified below at a junction temperature, T_j , of 85°C:

- 200mA – LUXEON CoB 1202s
- 200mA – LUXEON CoB 1202
- 300mA – LUXEON CoB 1203
- 450mA – LUXEON CoB 1204
- 600mA – LUXEON CoB 1205
- 900mA – LUXEON CoB 1208
- 1200mA – LUXEON CoB 1211

Part Number Nomenclature

Part numbers for LUXEON CoB with CrispWhite Technology (Gen 2) follow the convention below:

L 2 C 5 – 3 0 9 0 **A A A A E B B C 0**

Where:

- A A A A** – designates product configuration (1202, 1203, 1204, 1205, 1208, 1211)
- B B** – designates Light Emitting Surface (LES) size (06=6mm, 09=9mm, 13=13mm, 15=15mm, 19=19mm)

Therefore, the following part number is used for a LUXEON CoB 1203 with a 9mm LES:

L 2 C 5 – 3 0 9 0 **1 2 0 3 E 0 9 C 0**

Lumen Maintenance

Please contact your local Sales Representative or Lumileds Technical Solutions Manager for more information about the long-term performance of this product.

Environmental Compliance

Lumileds LLC is committed to providing environmentally friendly products to the solid-state lighting market. The second generation of LUXEON CoB with CrispWhite Technology is compliant to the European Union directives on the restriction of hazardous substances in electronic equipment, namely the RoHS Directive 2011/65/EU and REACH Regulation (EC) 1907/2006. Lumileds LLC will not intentionally add the following restricted materials to its products: lead, mercury, cadmium, hexavalent chromium, polybrominated biphenyls (PBB) or polybrominated diphenyl ethers (PBDE).

Performance Characteristics

Product Selection Guide

Table 1. Product performance of LUXEON CoB with CrispWhite Technology (Gen 2) at test current, $T_j=85^\circ\text{C}$.

PRODUCT	NOMINAL CCT	MINIMUM CRI ^[1, 2]	LUMINOUS FLUX ^[1, 3] (lm)		TYPICAL LUMINOUS EFFICACY (lm/W)	TEST CURRENT (mA)	LES ^[4] (mm)	PART NUMBER
			MINIMUM	TYPICAL				
LUXEON CoB 1202s	3000K	90	586	651	93	200	6	L2C5-30901202E06C0
LUXEON CoB 1202	3000K	90	611	679	97	200	9	L2C5-30901202E09C0
LUXEON CoB 1203	3000K	90	905	1006	96	300	9	L2C5-30901203E09C0
LUXEON CoB 1204	3000K	90	1421	1579	99	450	13	L2C5-30901204E13C0
LUXEON CoB 1205	3000K	90	1845	2050	97	600	13	L2C5-30901205E13C0
LUXEON CoB 1208	3000K	90	2750	3056	97	900	15	L2C5-30901208E15C0
LUXEON CoB 1211	3000K	90	3794	4215	100	1200	19	L2C5-30901211E19C0

Notes for Table 1:

1. Lumileds maintains a tolerance of ± 2 on CRI and $\pm 6.5\%$ on luminous flux measurements.
2. Typical CRI is approximately 2 points higher than the minimum CRI specified, but this is not guaranteed.
3. Maximum luminous flux is 10% above typical luminous flux.
4. Light Emitting Surface (LES) is the inner diameter (phosphor area) inside the dam.

Optical Characteristics

Table 2. Optical characteristics for LUXEON CoB with CrispWhite Technology (Gen 2) at test current, $T_j=85^\circ\text{C}$.

PART NUMBER	TYPICAL TOTAL INCLUDED ANGLE ^[1]	TYPICAL VIEWING ANGLE ^[2]
L2C5-309012xxExxC0	135°	115°

Notes for Table 2:

1. Total angle at which 90% of total luminous flux is captured.
2. Viewing angle is the off axis angle from the LED centerline where the luminous intensity is $\frac{1}{2}$ of the peak value.

Electrical and Thermal Characteristics

Table 3. Electrical and thermal characteristics for LUXEON CoB with CrispWhite Technology (Gen 2) at test current, $T_j=85^\circ\text{C}$.

PART NUMBER	FORWARD VOLTAGE ^[1] (V_f)			TYPICAL TEMPERATURE COEFFICIENT OF FORWARD VOLTAGE ^[2] (mV/ $^\circ\text{C}$)	TYPICAL THERMAL RESISTANCE—JUNCTION TO CASE ^[3] ($^\circ\text{C}/\text{W}$)
	MINIMUM	TYPICAL	MAXIMUM		
L2C5-30901202E06C0	33.0	35.0	38.0	-16	0.98
L2C5--30901202E09C0	33.0	35.0	38.0	-16	0.91
L2C5--30901203E09C0	33.0	35.0	38.0	-16	0.70
L2C5--30901204E13C0	33.0	35.3	38.0	-16	0.53
L2C5--30901205E13C0	33.0	35.3	38.0	-16	0.45
L2C5--30901208E15C0	33.0	35.1	38.0	-16	0.29
L2C5--30901211E19C0	33.0	35.2	38.0	-16	0.23

Notes for Table 3:

1. Lumileds maintains a tolerance of $\pm 2\%$ on forward voltage measurements.
2. Measured between 25°C and 85°C for coefficient forward voltage.
3. Thermal resistance is measured between junction and the bottom of the LUXEON CoB substrate.

Absolute Maximum Ratings

Table 4. Absolute maximum ratings for LUXEON CoB with CrispWhite Technology (Gen 2).

PARAMETER	MAXIMUM PERFORMANCE
DC Forward Current ^[1,2]	2x test current
LED Junction Temperature ^[1] (DC & Pulse)	125°C
ESD Sensitivity (ANSI/ESDA/JEDEC JS-001-2012)	Class 3B
Operating Case Temperature ^[1]	-40°C to 105°C
LED Storage Temperature	-40°C to 120°C
Allowable Reflow Cycles	3
Reverse Voltage (V_{reverse})	LUXEON LEDs are not designed to be driven in reverse bias

Notes for Table 4:

1. Proper current derating must be observed to maintain the junction temperature below the maximum allowable junction temperature.
2. Residual periodic variations due to power conversion from alternating current (AC) to direct current (DC), also called "ripple," are acceptable if the following conditions are met:
 - The frequency of the ripple current is 100Hz or higher
 - The average current for each cycle does not exceed the maximum allowable DC forward current
 - The maximum amplitude of the ripple does not exceed the maximum peak pulsed forward current
3. At 10% duty cycle with pulse width of 10ms.

Characteristic Curves

Spectral Power Distribution Characteristics

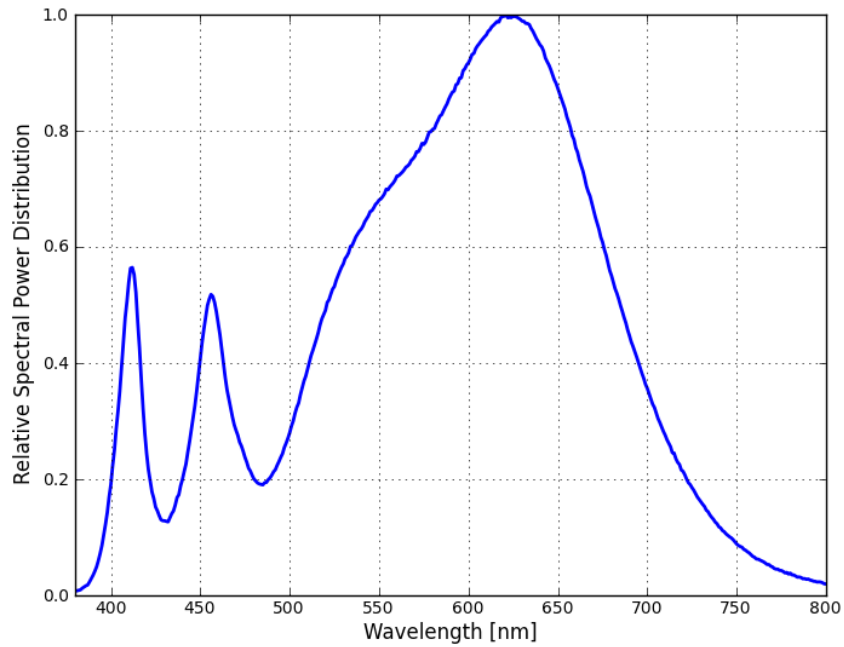

Figure 1. Typical normalized power vs. wavelength for LUXEON CoB with CrispWhite Technology (Gen 2) at test current, $T_j=85^\circ\text{C}$.

Light Output Characteristics

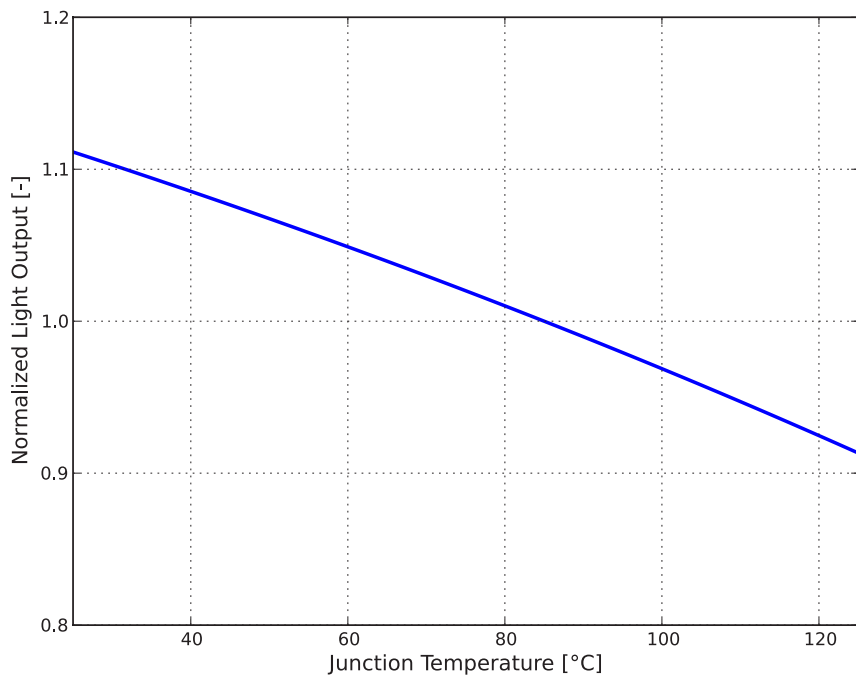
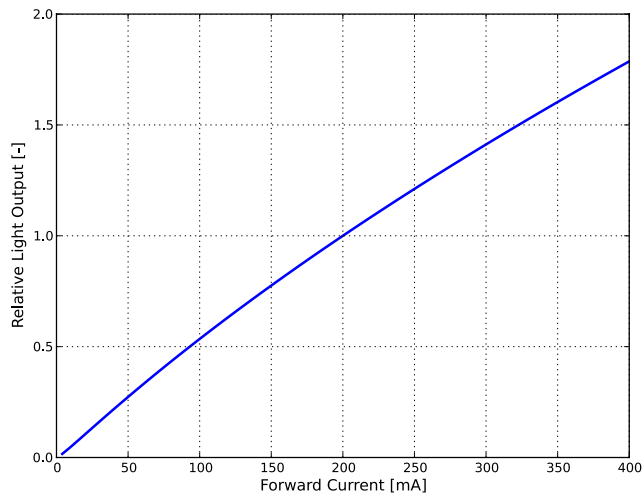
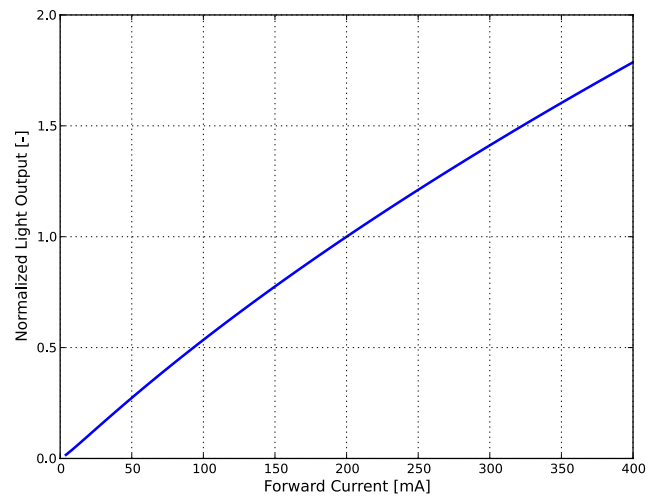

Figure 2. Typical normalized light output vs. junction temperature for LUXEON CoB with CrispWhite Technology (Gen 2) at test current.



L2C5-30901202E06C0



L2C5-30901202E09C0

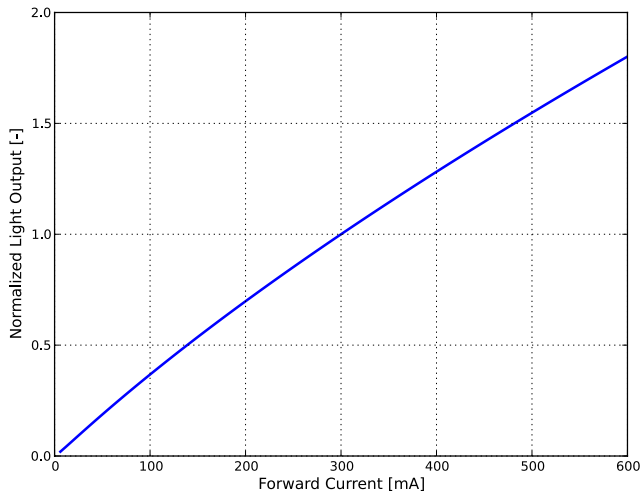

L2C5-30901203E09C0

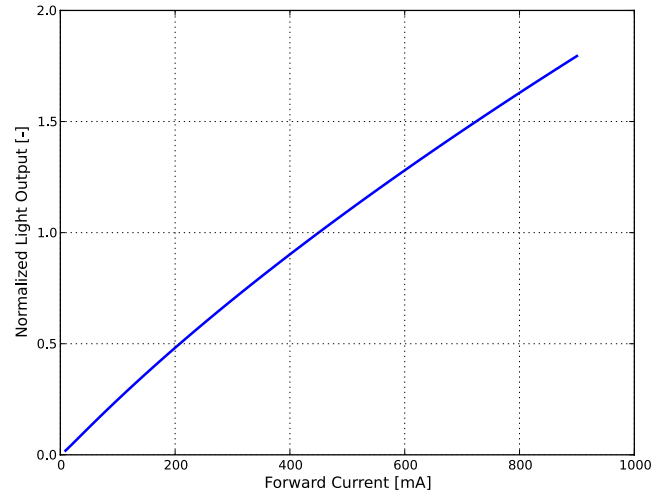

L2C5-30901204E13C0

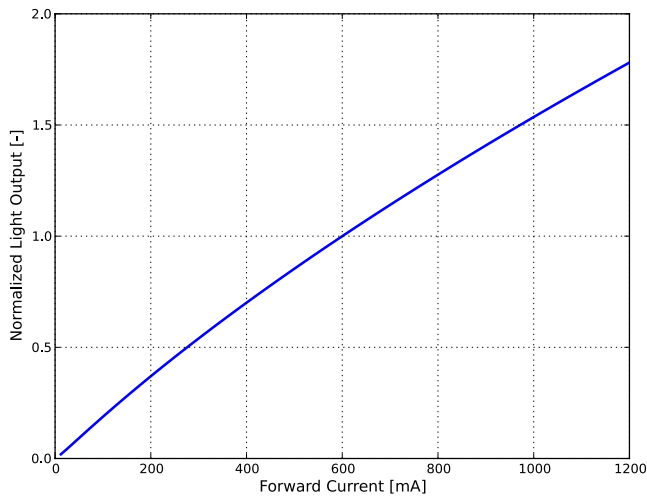

L2C5-30901205E13C0

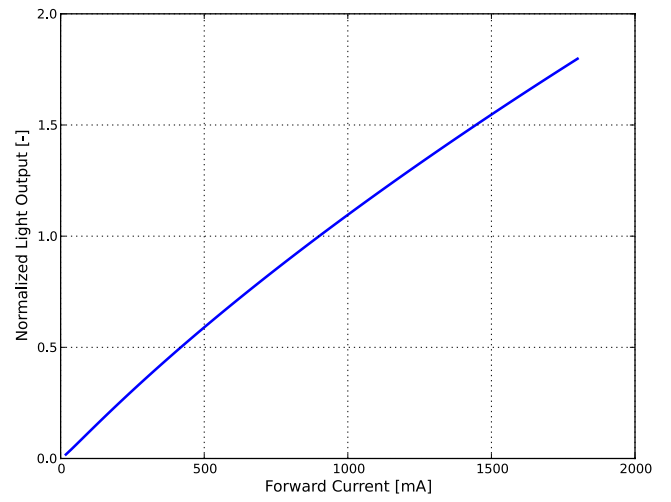

L2C5-30901208E15C0

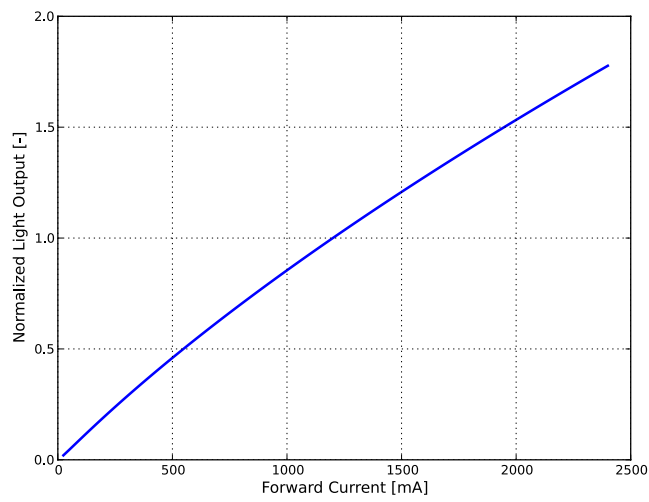

L2C5-30901211E19C0

Figure 3. Typical normalized light output vs. forward current for LUXEON CoB with CrispWhite Technology (Gen 2) at $T_j=85^\circ\text{C}$.

Forward Current Characteristics

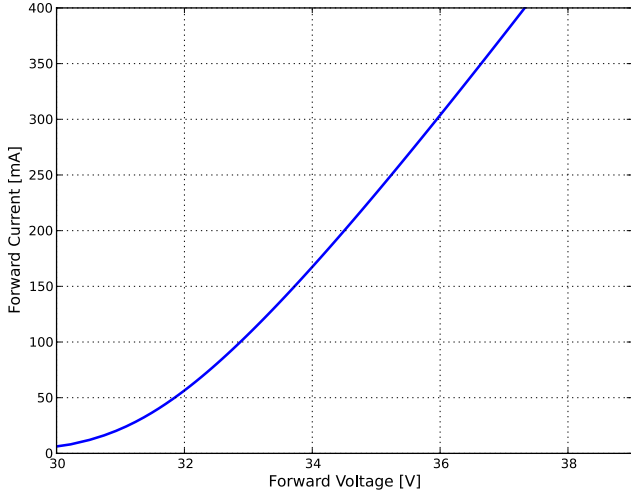

L2C5-30901202E06C0

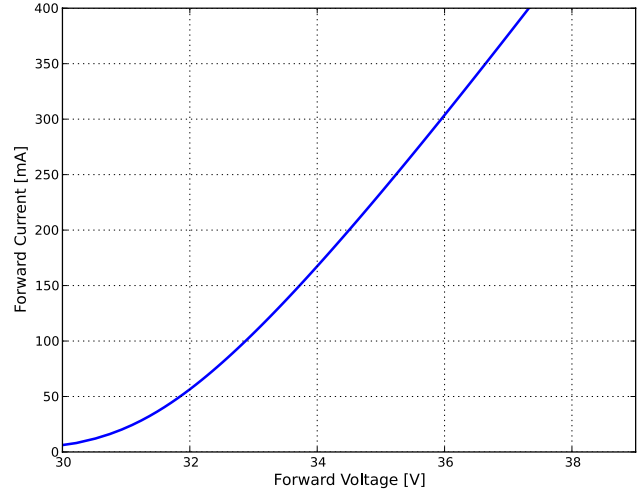

L2C5-30901202E09C0

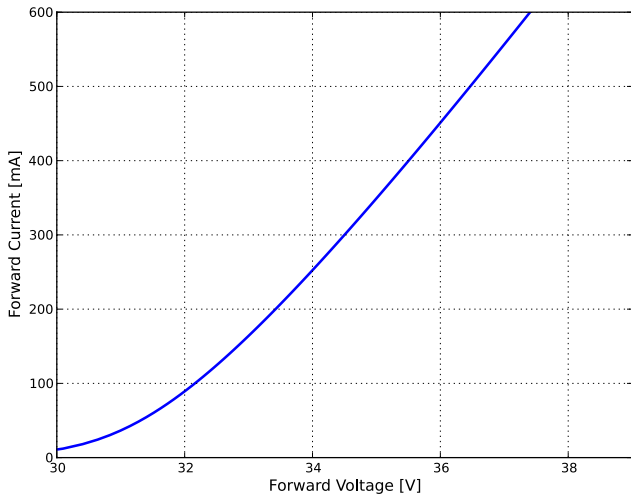

L2C5-30901203E09C0

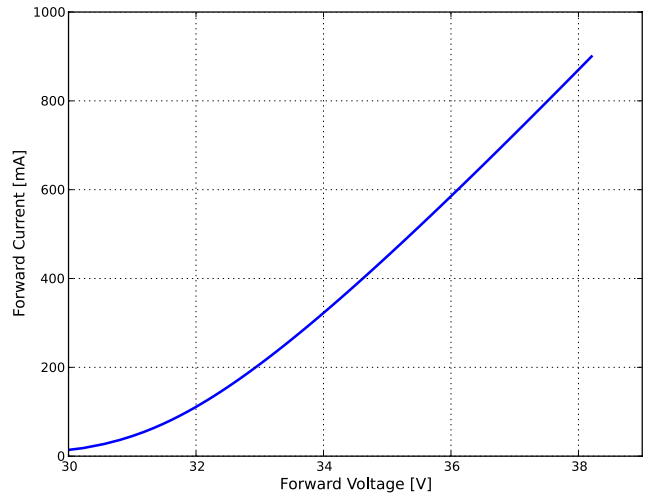

L2C5-30901204E13C0

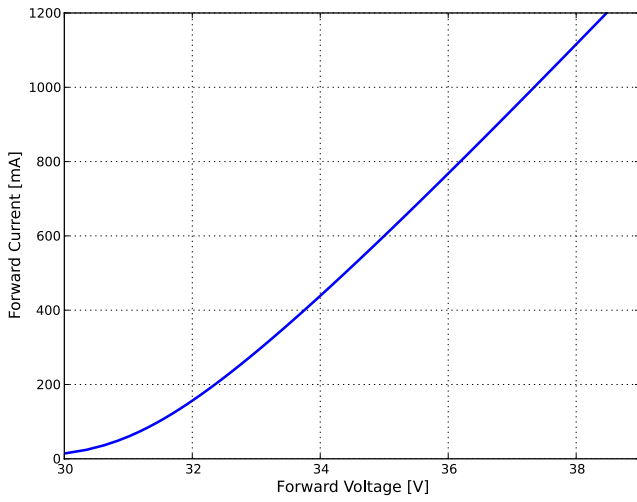

L2C5-30901205E13C0

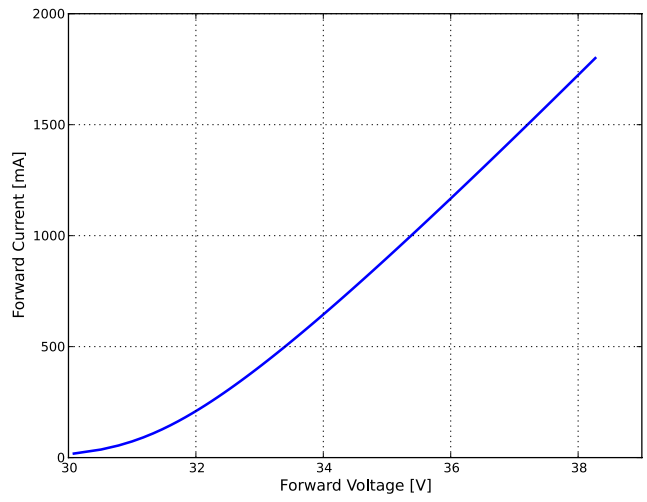

L2C5-30901208E15C0

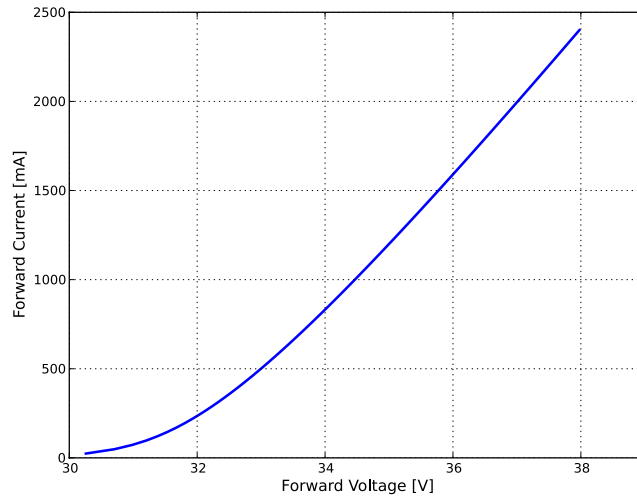

L2C5-30901211E19C0

Figure 4. Typical forward current vs. forward voltage for LUXEON CoB with CrispWhite Technology (Gen 2) at $T_j=85^\circ\text{C}$.

Radiation Pattern Characteristics

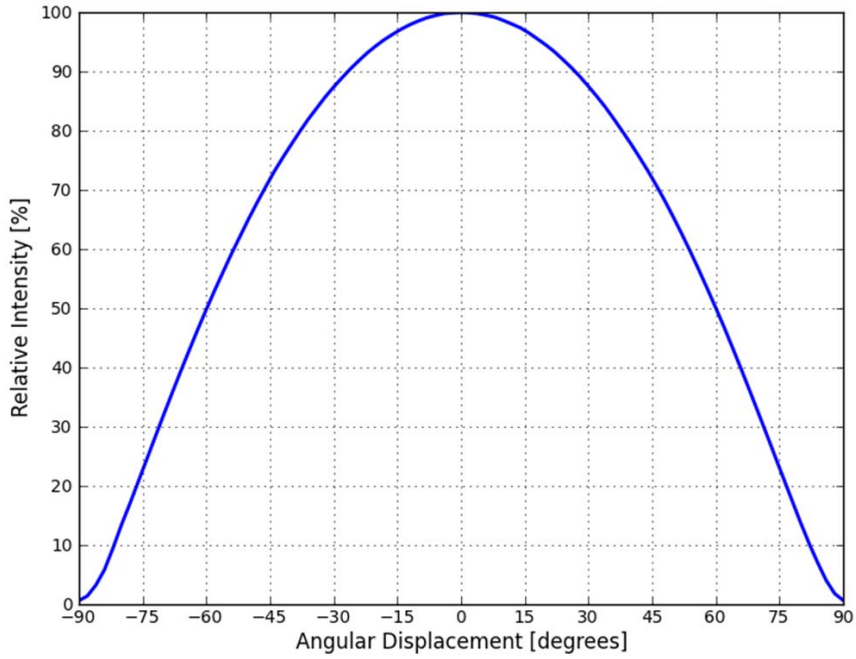

Figure 5. Typical radiation pattern for LUXEON CoB with CrispWhite Technology (Gen 2) at test current, $T_j=85^{\circ}\text{C}$.

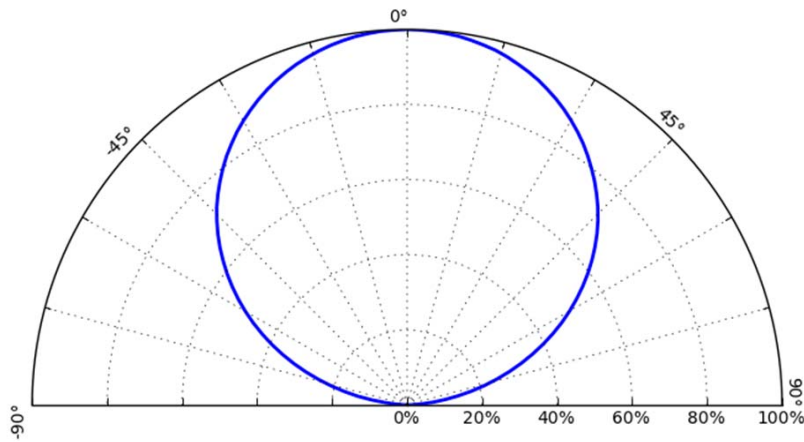

Figure 6. Typical polar radiation pattern for LUXEON CoB with CrispWhite Technology (Gen 2) at test current, $T_j=85^{\circ}\text{C}$.

Color Bin Definitions

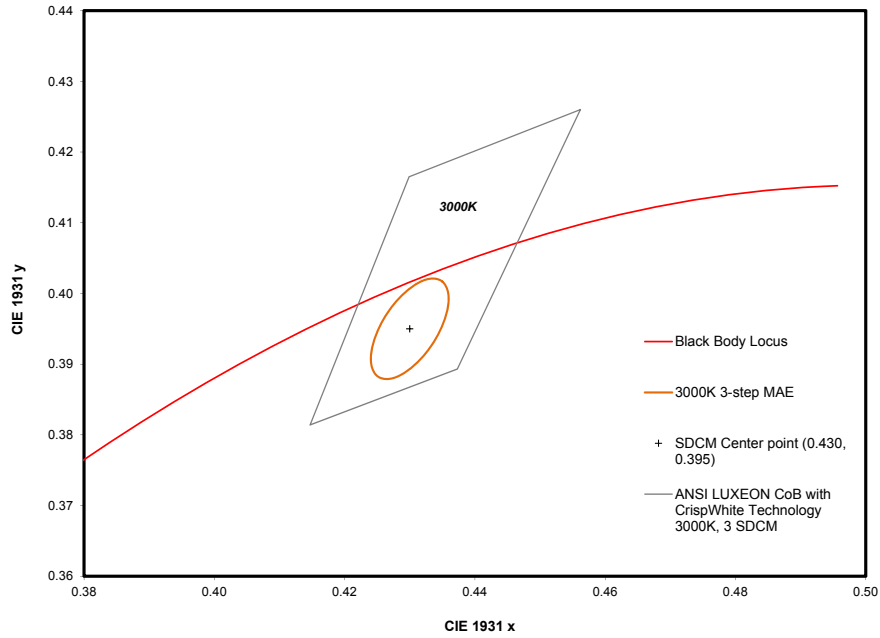

Figure 7. 3-step MacAdam ellipse illustration for Table 5.

Table 5. 3-step MacAdam ellipse color bin definition for LUXEON CoB with CrispWhite Technology (Gen 2).

NOMINAL CCT	COLOR SPACE	CENTER POINT ^[1] (cx, cy)	MAJOR AXIS, a	MINOR AXIS, b	ELLIPSE ROTATION ANGLE, θ
3000K	Single 3-step MacAdam ellipse	(0.430, 0.395)	0.00834	0.00408	53.20°

Notes for Table 5:

1. Lumileds maintains a tolerance of ± 0.005 on x and y coordinates in the CIE 1931 color space.

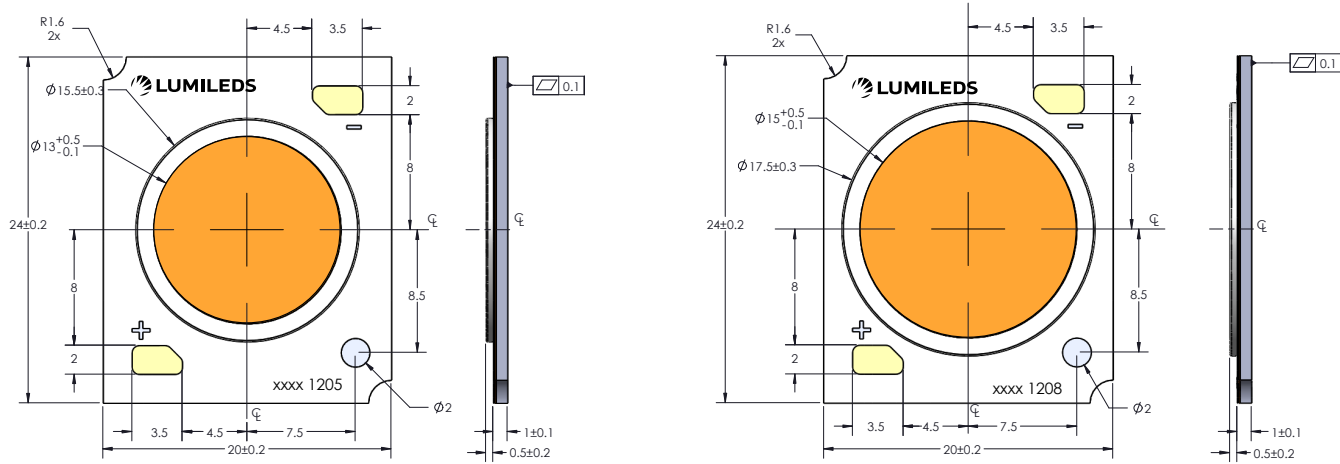

L2C5-30901205E13C0

L2C5-30901208E15C0

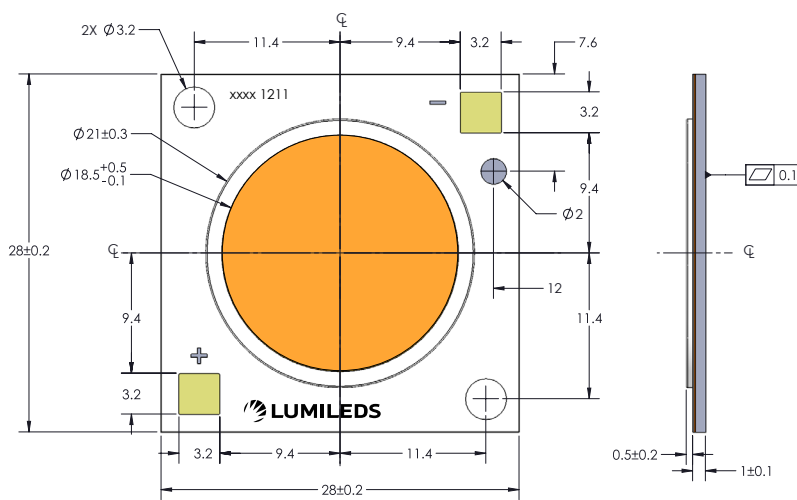

L2C5-30901211E19C0

Figure 8. Mechanical dimensions for LUXEON CoB with CrispWhite Technology (Gen 2).

Packaging and Labeling Information

The second generation of LUXEON CoB with CrispWhite Technology LEDs are packaged in tubes then in a carton box. Each tube contains a specified number of LEDs. The LEDs in each tube come from a single category code, ensuring they are all well-matched for light output, color, and forward voltage. Each tube contains a rubber stopper at one end. The tube label has both alphanumeric and bar code information. The carton boxes have printed information providing part numbers with CAT codes that indicate luminous flux, color and forward voltage bins.

Table 6. Package information for LUXEON CoB with CrispWhite Technology (Gen 2).

PART NUMBER	TOTAL UNITS PER TUBE	TOTAL TUBES PER INNER BOX	TOTAL UNITS PER INNER BOX
L2C5-30901202E09C0	20	5	100
L2C5-30901202E09C0	20	5	100
L2C5-30901203E09C0	20	5	100
L2C5-30901204E13C0	20	5	100
L2C5-30901205E13C0	20	5	100
L2C5-30901208E15C0	20	5	100
L2C5-30901211E19C0	10	5	50

Tube Dimensions

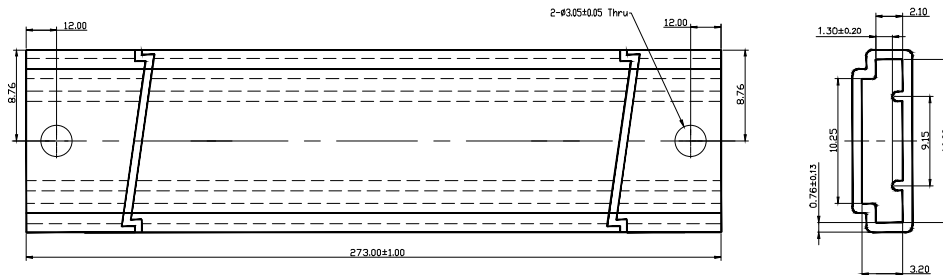

Figure 9a. Tube dimensions for L2C5-30901202E06C0.

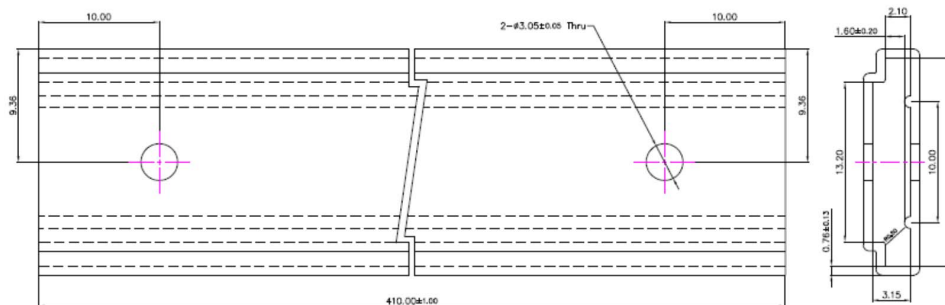

Figure 9b. Tube dimensions for L2C5-3090120xE09C0.

- Notes for Figures 9a and 9b:
1. Drawings not to scale.
 2. All dimensions are in millimeters.

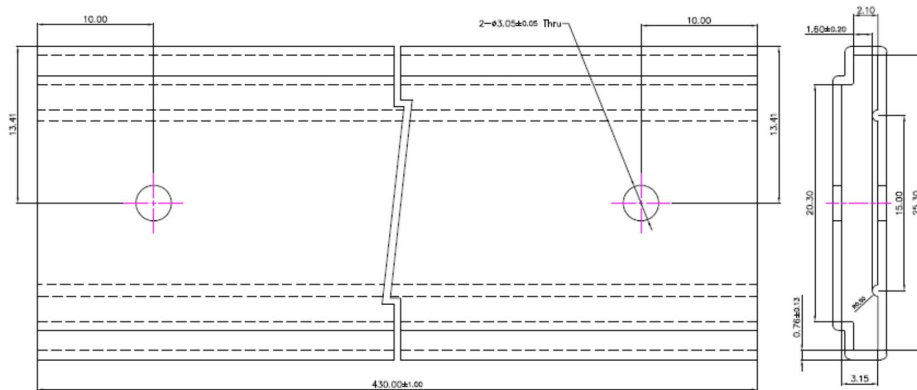

Figure 9c. Tube dimensions for L2C5-3090120xE13C0 and L2C5-30901208E15C0.

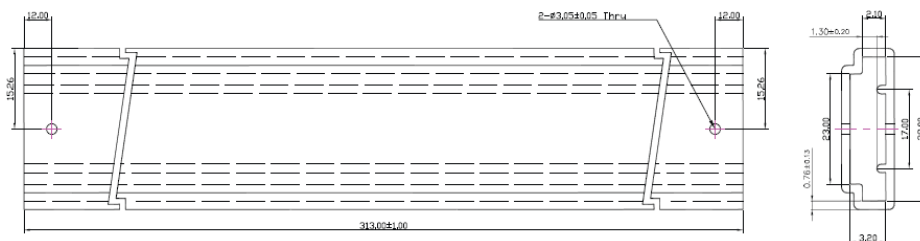

Figure 9d. Tube dimensions for L2C5-30901211E19C0.

Notes for Figures 9c and 9d:

1. Drawings not to scale.
2. All dimensions are in millimeters.

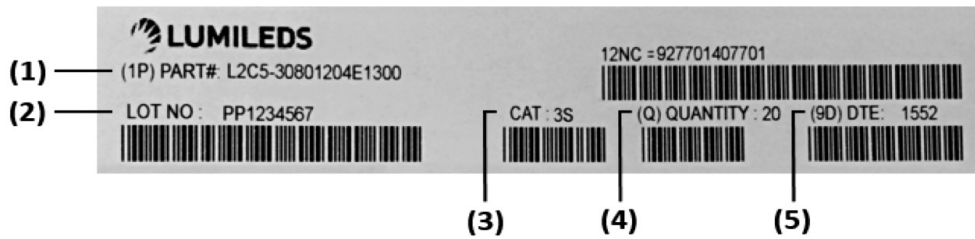

Figure 10. Example of a tube label for LUXEON CoB with CrispWhite Technology (Gen 2).

Notes for Figure 10 - Tube Label descriptions for customer use:

Field labels not described are for Lumileds internal use only.

1. Lumileds part number.
2. Unique production lot identification number. This number is required for traceability purpose.
3. Product category code.
4. Number of LED emitters in a tube.
5. LED test date in YYWW format.

Inner Box

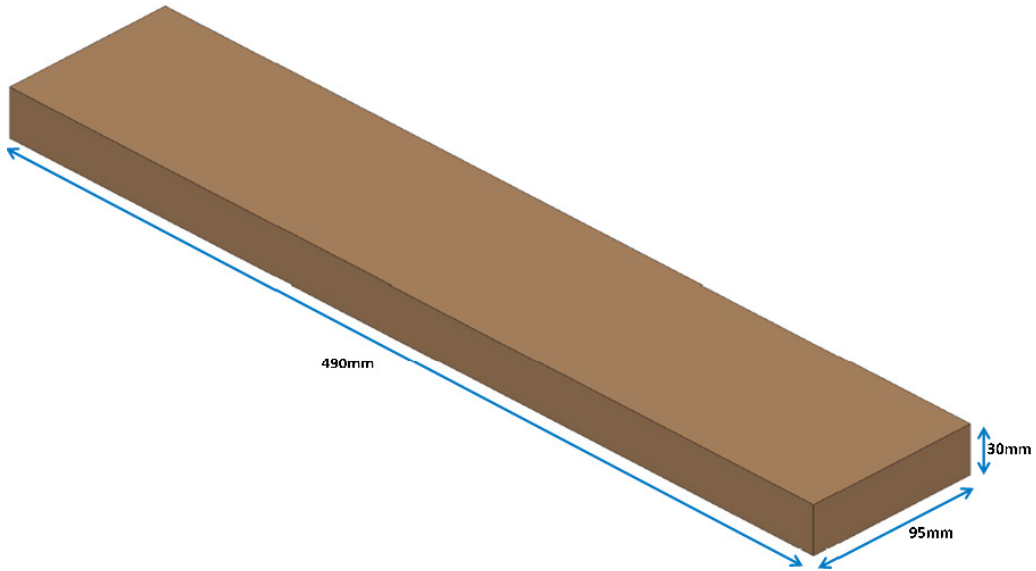

Figure 11. Dimensions for inner box packaging for LUXEON CoB with CrispWhite Technology (Gen 2).

Table 7. Inner box information for LUXEON CoB with CrispWhite Technology (Gen 2).

BOX TYPE	DIMENSIONS (mm)			AVERAGE WEIGHT (100PCS/BOX)	AVERAGE WEIGHT (50PCS/BOX)
	H	L	W		
Inner Box	30	490	95	0.340Kg	0.305Kg



Figure 12. Example of inner box label for LUXEON CoB with CrispWhite Technology (Gen 2).

Notes for Figure 12 - Tube Label descriptions for customer use:
Field labels not described are for Lumileds internal use only.

1. Lumileds part number.
2. Number of LED emitters in a box.
3. LED test date in YYWW format.
4. Customer part number for custom requests only.
5. Unique production lot identification number. This number is required for traceability purpose.
6. Product category code.

Outer Box

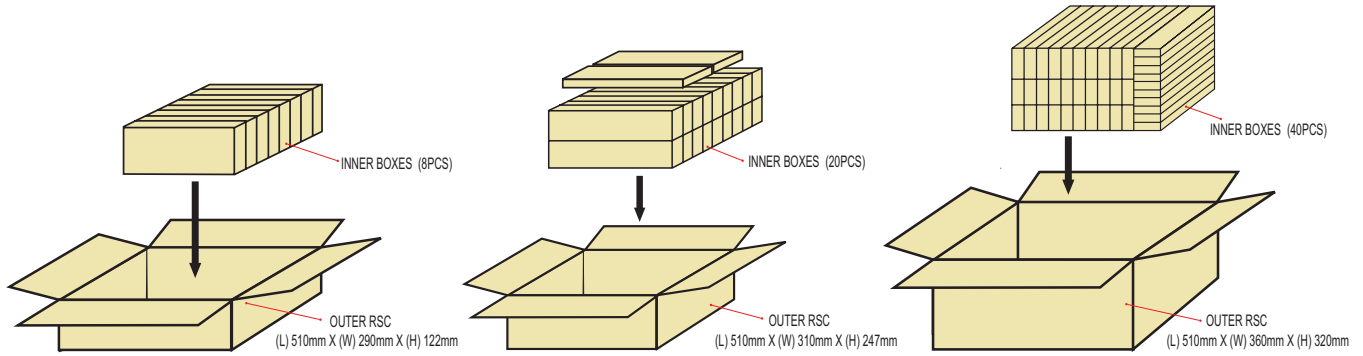

Figure 13. Dimensions for outer box packaging for LUXEON CoB with CrispWhite Technology (Gen 2).

Table 8. Outer box information for LUXEON CoB with CrispWhite Technology (Gen 2).

BOX TYPE	DIMENSIONS (mm)			MAXIMUM INNER BOXES PER OUTER BOX	MAXIMUM QUANTITY PER OUTER BOX	AVERAGE WEIGHT (100pcs/box)	AVERAGE WEIGHT (50pcs/box)
	H	L	W				
Outer Box 8 PCS	122	510	290	8	800	3.05kg	2.77kg
Outer Box 20 PCS	247	510	310	20	2000	7.55kg	6.85kg
Outer Box 40 PCS	320	510	360	40	4000	15.10kg	13.70kg

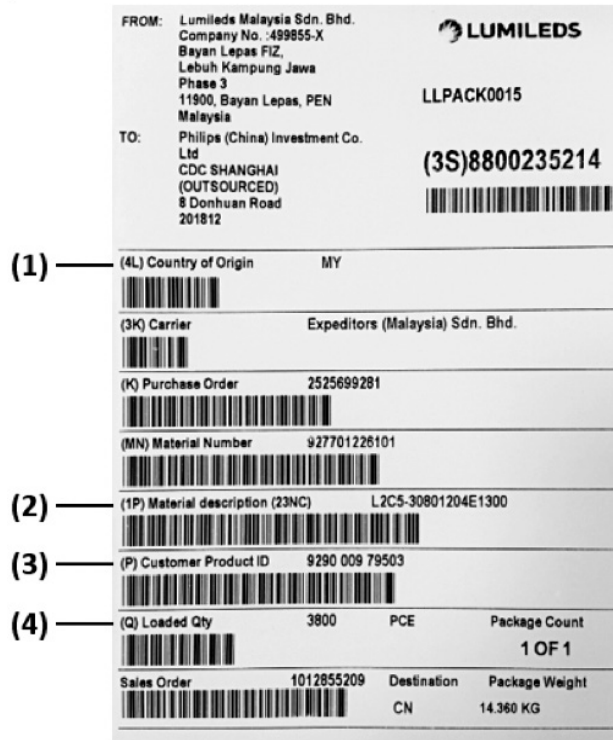

Figure 14. Example of outer box label for LUXEON CoB with CrispWhite Technology (Gen 2).

Notes for Figure 14 - Tube Label descriptions for customer use:

Field labels not described are for Lumileds internal use only.

1. Country code of origin of manufacturing of parts (e.g. MY for Malaysia, CN for China) according to ISO 3166-1 alpha-2 document.
2. Lumileds part number.
3. Customer part number for custom requests only.
4. Total number of LED emitters in a shipment box.

About Lumileds

Lumileds is the global leader in light engine technology. The company develops, manufactures and distributes groundbreaking LEDs and automotive lighting products that shatter the status quo and help customers gain and maintain a competitive edge.

With a rich history of industry “firsts,” Lumileds is uniquely positioned to deliver lighting advancements well into the future by maintaining an unwavering focus on quality, innovation and reliability.

To learn more about our portfolio of light engines, visit lumileds.com.



©2016 Lumileds Holding B.V. All rights reserved.
LUXEON is a registered trademark of the Lumileds Holding B.V.
in the United States and other countries.

lumileds.com

Neither Lumileds Holding B.V. nor its affiliates shall be liable for any kind of loss of data or any other damages, direct, indirect or consequential, resulting from the use of the provided information and data. Although Lumileds Holding B.V. and/or its affiliates have attempted to provide the most accurate information and data, the materials and services information and data are provided “as is,” and neither Lumileds Holding B.V. nor its affiliates warrants or guarantees the contents and correctness of the provided information and data. Lumileds Holding B.V. and its affiliates reserve the right to make changes without notice. You as user agree to this disclaimer and user agreement with the download or use of the provided materials, information and data.